

NEW



EAN code
 HRN-31: 8595188184946
 HRN-31/2: 8595188184380
 HRN-32/2: 8595188185394
 HRN-36: 8595188184953
 HRN-36/2: 8595188182553
 HRN-39: 8595188184960
 HRN-39/2: 8595188184939

Technical parameters	HRN-31 HRN-31/2	HRN-32/2	HRN-36 HRN-36/2	HRN-39 HRN-39/2
----------------------	--------------------	----------	--------------------	--------------------

Supply and measuring

Supply/monitored terminals:	A1-A2			
Supply/monitored voltage:	AC/DC 48 – 276 V (AC 50–60 Hz)	AC/DC 48 – 276 V (AC 50–60 Hz)	DC 6 – 30 V	AC/DC 24 – 150 V (AC 50–60 Hz)
Consumption (max.):	2.5 VA/0.55 W 2.7 VA/0.65 W	2.7 VA/0.65 W	- 0.35 W	2.5 VA/0.55 W 2.7 VA/0.65 W
Upper level setting (Umax):	AC 160 – 276 V	AC 160 – 276 V	DC 12 – 30 V	AC 80 – 150 V
Lower level setting (Umin):	30 – 95 %Umax	30 – 95 %Umax	50 – 95 %Umax	30 – 95 %Umax
Max. permanent voltage:	AC 276 V	AC 276 V	DC 36 V	AC 276 V
Peak overload (1 s):	AC 290 V	AC 290 V	DC 48 V	AC 290 V
Time delay (d):	300 ms			
Time delay (t):	adjustable, 0.5 – 10 s			

Accuracy

Setting accuracy (mech.):	5 % – mechanical setting
Repeat accuracy:	< 1 %
Temperature dependency:	< 0.1 %/°C (°F)
Hysteresis (fault to OK):	5 % (functions O1, U1, W) Umax – Umin (functions O2, U2, U3)

Output

Contact type:	1x changeover 2x changeover	1x changeover for each level	1x changeover 2x changeover	1x changeover 2x changeover
Contact material:	AgNi			
Current rating:	16 A/AC1			
Breaking capacity:	4000 VA/AC1, 384 W/DC1			
Switching voltage:	250 V AC/24 V DC			
Power dissipation (max.):	1.2 W			
Mechanical life:	10.000.000 ops.			
Electrical life (AC1):	100.000 ops.			

Other information

Operating temperature:	-20 .. +55 °C (-4 .. 131 °F)
Storage temperature:	-30 .. +70 °C (-22 .. 158 °F)
Dielectric strength:	AC 4 kV (supply – output)
Operating position:	any
Mounting:	DIN rail EN 60715
Protection degree:	IP40 front panel / IP20 terminals
Overvoltage category:	III.
Pollution degree:	2
Cross-wire section – solid/ stranded with ferrule (mm ²):	max. 1x 2.5, 2x 1.5/ max. 1x 2.5 (AWG 14)
Dimensions:	90 × 17.6 × 64 mm (3.5" × 0.7" × 2.5")
Weight:	60 g (2.11 oz) 80 g (2.82 oz) 59 g (2.08 oz) 60 g (2.11 oz)
Standards:	EN 60255-1, EN 60255-26, EN 60255-27

- It is used to monitor the value of alternating or direct voltage in 1-phase circuits.
- Supply voltage from monitored voltage.
- Monitors voltage exceeding the upper voltage level (Umax) and falling below the lower voltage level (Umin) – according to the selected function.
- Smooth adjustment of both voltage levels – the lower level Umin is set in % of the upper level Umax.
- Adjustable time delay (to eliminate short-term voltage drops and spikes).
- Option to select functions with fault state memory (Latch).
- The fault state memory can be reseted by the control input (R).
- Measures true root mean square value of the voltage - TRUE RMS.
- Type HRN-32/2 has an independent output contact for each voltage level.

Description

HRN-31/2

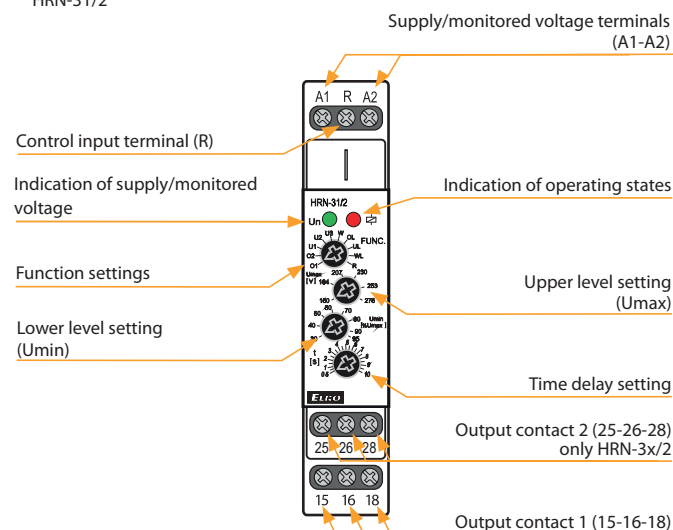

Connection

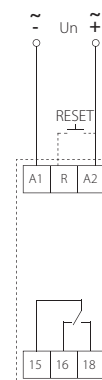

Indication of operating states

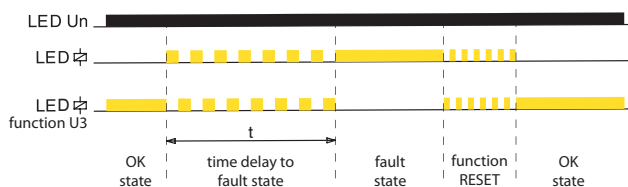

Function

O1 OVER (hysteresis 5%)

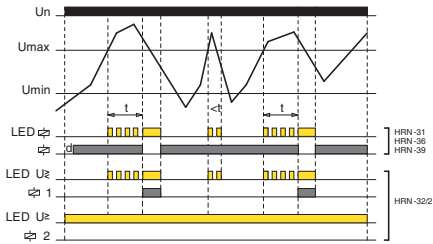

U1 UNDER (hysteresis 5%)

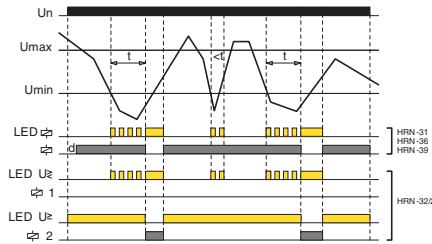

UL UNDER + Latch

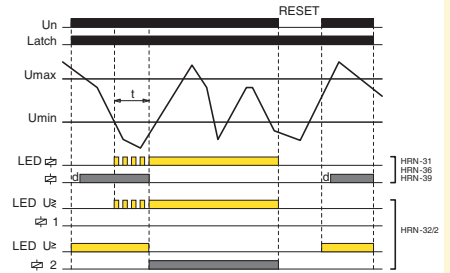

O2 OVER (hysteresis to Umin)

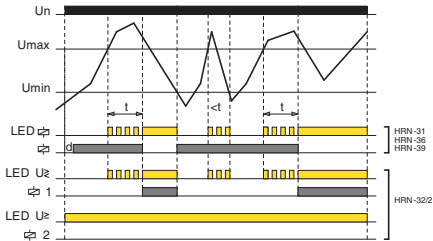

U2 UNDER (hysteresis to Umax)

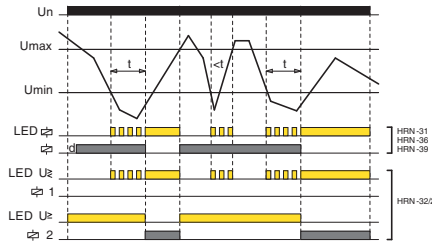

W WINDOW (hysteresis 5%)

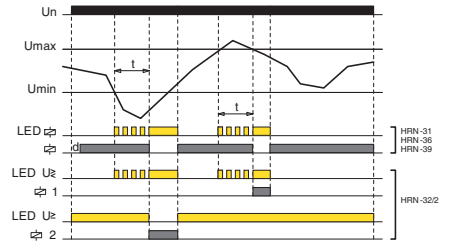

OL OVER + Latch

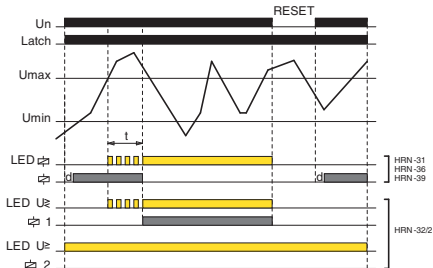

U3 UNDER (hysteresis to Umax)

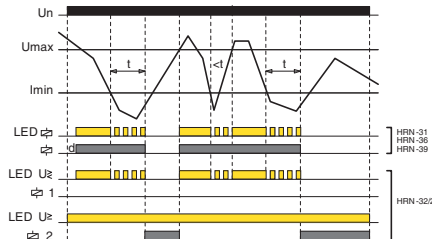

WL WINDOW + Latch

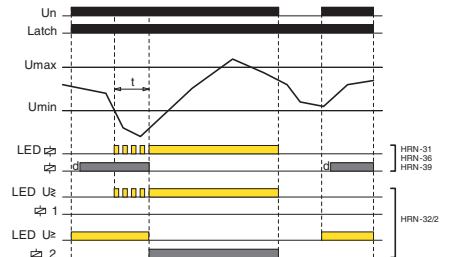

OVER:

If the value of the monitored voltage is lower than the set upper level „Umax“, the output contact is closed. If the „Umax“ is exceeded, the output contact will opens after the set delay (fault state).

If the voltage falls below the fixed hysteresis (O1 function) or the set lower level „Umin“ (O2 function), the output contact will closes again.

If the OL function (OVER + Latch) is selected, when the upper voltage level „Umax“ is exceeded, the output contact remains open even when the voltage returns from the fault state.

Fault memory reset can be done in two ways:

- Short-term interruption of supply voltage
- Using the control input (R)
- By setting the function switch to position R (RESET) or any function without memory fault

The RESET state lasts for 3 s after switching the function switch from the R position to a function with a memory fault (UL, OL, WL).

When moving to any other function from the R position, this delay does not apply.

UNDER:

If the value of the monitored voltage is higher than the set lower level „Umin“, the output contact is closed. When the voltage drops below the „Umin“, output contact opens after the set delay (fault state).

If the voltage exceeds the fixed hysteresis (function U1) or the set upper level „Umax“ (function U2, U3), the output contact closes again.

If the UL function (UNDER + Latch) is selected, when the voltage drops below the lower level „Umin“, the output contact remains open even when returning from the fault state. Fault memory reset can be done as in the previous case.

WINDOW:

If the value of the monitored voltage is lower than upper level „Umax“ and at the same time higher than lower level „Umin“, the output contact is closed. If the „Umax“ is exceeded or drops below the „Umin“, output contact opens after the set delay (fault state).

To return from the fault state, a fixed hysteresis is applied.

If the WL function (WINDOW + Latch) is selected, the fault state is again stored in memory and output contact stays open, even when returning from the fault state. Fault memory reset can be done as in the previous cases.